

17-5174-01 Superdex™ 75 10/300 GL and  
17-5175-01 Superdex 200 10/300 GL

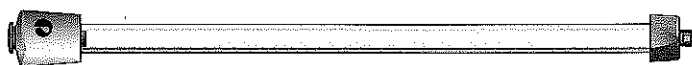

### Quick information

Superdex 75 10/300 GL and Superdex 200 10/300 GL are Tricorn™ high performance columns. The columns are pre-packed glass columns for high performance gel filtration of proteins, peptides, DNA fragments (<200 bp) and other biomolecules.

The column is supplied with two fingertight connectors 1/16" male for connection to ÄKTA™ design systems and two union 1/16" male/M6 female for connection to a FPLC™ system.

### Column data

Matrix	Composite of cross-linked agarose and dextran	
Bed dimensions	10 x 300–310 mm	
Bed volume	Approximately 24 ml	
Column efficiency, N/M	>30 000 m <sup>-1</sup>	
Average Particle Size	13 µm	
pH stability range	3–12	
regular use	1–14	
cleaning		
Temperature operating	+4 to +40 °C	
storage	+4 to +30 °C	
Exclusion limit, M <sub>r</sub> , globular proteins	Superdex 75 Approx. 1 x 10 <sup>5</sup>	Superdex 200 Approx. 1.3 x 10 <sup>5</sup>
Optimum separation range globular proteins, M <sub>r</sub> , dextrans	3 000–70 000 500–30 000	10 000–600 000 1000–100 000
Flow rate (water at room temperature) recommended maximum	0.5–1.0 ml/min 1.5 ml/min	0.25–0.75 ml/min 1 ml/min
Pressure over column maximum	1.8 MPa, 18 bar, 261 psi	1.5 MPa, 15 bar, 218 psi

### First-time use

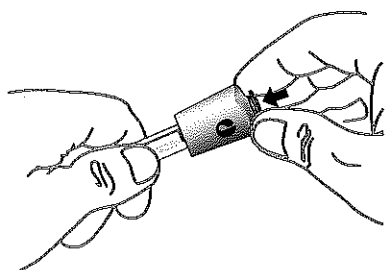

**Fig 1.** Illustration of how to lock the adapter. The locking ring (black) must be in the down-position to prevent uncontrolled adjustment of the column's bed height.

Before connecting the column to a chromatography system, ensure there is no air in the tubing and valves. Remove the storage/shipping device and the stop plug from the column. Check that the upper adapter is locked (locking ring pressed down, see figure 1). Make sure that the column inlet is filled with liquid and connect it drop-to-drop to the system.

Equilibrate the column for first-time use or after long term storage as follows:

- At least 50 ml distilled H<sub>2</sub>O at a flow rate of 0.5 ml/min.
- 50 ml eluent at a flow rate of 0.5 ml/min.

**Note:** Ensure that the back-pressure over the column does not exceed the maximum recommended pressure (1.8 MPa for Superdex 75 and 1.5 MPa for Superdex 200). This is particularly important when working at low temperatures, like in cold room.



 Tricorn

### Try these conditions first

Eluent:	50 mM phosphate buffer, 0.15 M NaCl, pH 7.0
Flow rate:	0.5–0.75 ml/min, room temperature
Sample volume:	25 µl

Equilibration is not necessary between runs with the same eluent buffer. Read the section "Optimization" for information on how to optimize a separation.

### Buffers and solvent resistance

Install an on-line filter before the injection valve. Buffers and solvents with increased viscosity will affect the back-pressure and flow rate. De-gas and filter oil solutions through a 0.22 µm filter.

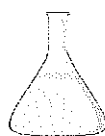

#### Daily use

All commonly used aqueous buffers, pH 3–12  
Urea, up to 8 M  
Acetonitrile, up to 30% in aqueous buffers  
Ionic and non-ionic detergents  
Guanidine hydrochloride, up to 6 M  
Trifluoroacetic acid, up to 10%  
Formic acid, up to 70%

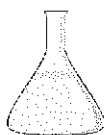

#### Cleaning

Acetonitrile, up to 30%  
Sodium hydroxide, up to 1 M  
Ethanol, up to 70%  
Methanol, up to 100%  
Acetic acid, up to 1 M  
Isopropanol, up to 30%  
Hydrochloric acid, up to 0.1 M



#### Avoid:

Oxidizing agents  
Unfiltered solutions

### Sample recommendations

Molecular weight, M <sub>r</sub>	3 000–70 000 (Superdex 75) 10 000–600 000 (Superdex 200)
Protein concentration	≤ 10 mg in sample
Sample volume	25–500 µl
Preparation	Dissolve the sample in eluent, filter through a 0.22 µm filter or centrifuge at 10 000 g for 10 min.



### In-depth information

#### Delivery/storage

The column is delivered with a storage/shipping device that keeps the pressure in the column and thereby prevents it from drying out. The column is equilibrated with degassed 20% ethanol.

If the column is to be stored for more than 2 days after use, wash the column with 2 column volumes of distilled water and then equilibrate with at least 2 column volumes of 20% ethanol. We recommend that you connect the storage/shipping device according to "How to connect the storage/shipping device" for long term storage.

The glass tube is coated with a protecting plastic film. Small quantities of air may occasionally be trapped between the glass and the film during manufacture. The resulting uneven surface does not affect column performance or durability.

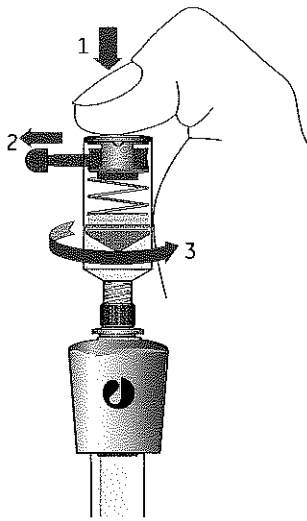

#### How to remove the storage/shipping device.

- (1) Push down the spring-loaded cap
- (2) Remove the locking pin
- (3) Release the cap and unscrew the device

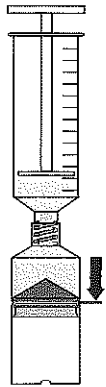

#### How to refill the storage/shipping device.

- (1) Connect a syringe or pump to the storage/shipping device and fill with 20% ethanol over the mark on the tube. Remove the syringe or connection to the pump.
- (2) Top out air bubbles and push the plunger to the mark on the device.

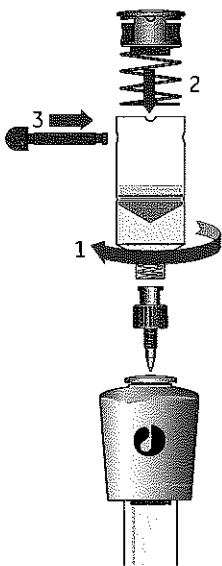

#### How to connect the storage/shipping device.

- (1) Fill the column inlet and luer connector with 20% ethanol and connect the filled storage/shipping device drop-to-drop to the top of the column.
- (2,3) Mount the spring-loaded cap and secure it with the locking pin.

#### Choice of eluent

Select an eluent that ensures the sample is fully soluble. Also try to choose an eluent that will simplify downstream applications. For example, if the proteins/peptides are to be lyophilized, a volatile eluent is necessary. As certain pH 7.0 dependent interactions can occur with both acidic and basic proteins at very low salt concentrations, a recommended buffer is 50 mM sodium phosphate, 0.15 M NaCl, pH 7.0. Table 1 lists some useful eluent compositions.

**Table 1.** Useful eluent compositions.

pH	Buffer/eluent	Properties/application examples
5.0	0.1 M ammonium acetate	Good solubility for some enzymes, e.g. cellulases. Volatile.
7.2	0.05 M phosphate + 0.15 M NaCl	Physiological conditions.
7.8	0.15 M ammonium hydrogen carbonate	Suitable for some DNA and protein separations. Volatile. Should be used fresh.
8.0	0.1 M Tris/HCl, 1 mM EDTA	Very good solubility for DNA and RNA.
8.6	6 M guanidine hydrochloride in 50 mM Tris-HCl	Good UV-transparency. Suitable if it is a need to purify proteins under denaturing conditions.
11.5	0.05 M NaOH	Good solubility for some compounds.

#### Buffer additives

30% acetonitrile in suitable buffer	For separating very hydrophobic compounds. Volatile.
Up to 8 M urea (pH<7)	Good solubility for many components. Biological activity can be maintained at lower urea contents. Certain risk for carbamylation of proteins.
6 M guanidine hydrochloride	Molecular weight determinations of subunits.
0.1% SDS, Tween or similar	Good solubility for some proteins, e.g. membrane proteins. Make sure you equilibrate completely with the detergent solution.

#### Optimization

Perform a first run as described in the section "Try these conditions first". If the results obtained are unsatisfactory, consider the following:

Action	Effect
Decrease the flow rate	Improves resolution for high molecular weight components. The resolution for small components may be decreased.
Decrease the sample volume	Improves resolution.
Change concentration of organic solvent	Changes selectivity.
Connect two columns in series	Increases resolution due to increased bed height. Keep the total back-pressure below 3 MPa for Superdex 75 10/300 GL and 2.5 MPa for Superdex 200 10/300 GL.

For more information, please refer to the handbook "Gel filtration, Principles & Methods", which can be ordered from GE Healthcare, or the "Method Handbook" supplied with each ÄKTAdesign system.

## Cleaning in place (CIP)

Perform the following regular cleaning cycle after 10–20 separation cycles.

### Regular cleaning:

1. Wash the column with 25 ml 0.5 M sodium hydroxide alternatively 0.5 M acetic acid at a flow rate of 0.5 ml/min.
2. Immediately rinse the column with 25 ml distilled water followed by at least 50 ml eluent buffer at a flow rate of 0.5 ml/min.

Before the next run, equilibrate the column until the UV baseline and pH are stable.

### More rigorous cleaning:

1. Change the filter at the top of the column. (Since contaminants are introduced with the liquid flow, many of them are caught by the filter.) Instructions for changing the filter are supplied with the Filter Kit. Perform a regular cleaning as described above.

Depending on the nature of the contaminants, one of the cleaning solutions on the previous page may be used. Always rinse with at least 2 column volumes of distilled water after any of the cleaning solutions has been used.

If column performance is still not restored, inject a solution of 1 mg/ml pepsin in 0.1 M acetic acid containing 0.5 M NaCl and leave overnight at room temperature or one hour at 37 °C. After enzymatic treatment, clean the column according to the procedure described in the section "Regular cleaning".

If necessary, resuspend 2–3 mm of the top of the gel bed and remove it with a Pasteur pipette. Adjust the adaptor to eliminate the space above the gel.

## Troubleshooting

### Symptom

Increased back-pressure over the column and/or loss of resolution

### Remedy

Confirm that the column is the cause (see below). If so, clean it according to the procedure described in the section "More rigorous cleaning".

To confirm that the high back-pressure in the system is caused by the column, disconnect one piece of equipment at a time (starting at the fraction collector) with the pumps working. Check the pressure reading after each piece is disconnected to determine the source of the back-pressure.

Air in the column

Run 80–100 ml well de-gassed eluent buffer at a flow rate of 0.5 ml/min. Note that small amounts of air will normally not affect the performance of the column.

## Column performance control

Check the performance of the column using the following procedure:

Sample: 100 µl 0.5% acetone (5mg/ml)  
Eluent: buffer solution or distilled H<sub>2</sub>O  
Flow rate: 0.75 ml/min, room temperature  
Detection: 280 nm

Column efficiency, expressed as the number of theoretical plates per meter, N/m, is calculated using the following equation:

$$N/m = 5.54 \times (v_r / w_{0.5})^2 \times (1000/L)$$

where

N/m = number of theoretical plates/meter

v<sub>r</sub> = peak elution distance (m)

w<sub>0.5</sub> = peak width at half peak height (m)

L = bed height (m)

As an alternative to the above efficiency test, check the column performance by running the function test described in Figure 2 and 3.

### Column Superdex 75 10/300 GL

Sample:

1. BSA (M, 67 000) 8 mg/ml
2. Ovaalbumin (M, 43 000) 2.5 mg/ml
3. Ribonuclease A (M, 13 700) 5 mg/ml
4. Aprotinin (M, 6 512) 2 mg/ml
5. Vitamin B12 (M, 1355) 0.1 mg/ml

Sample volume: 500 µl

Eluent: 0.05 M phosphate buffer, 0.15 M NaCl, pH 7.0

Flow rate: 0.4 ml/min, room temperature

Detection: 280 nm

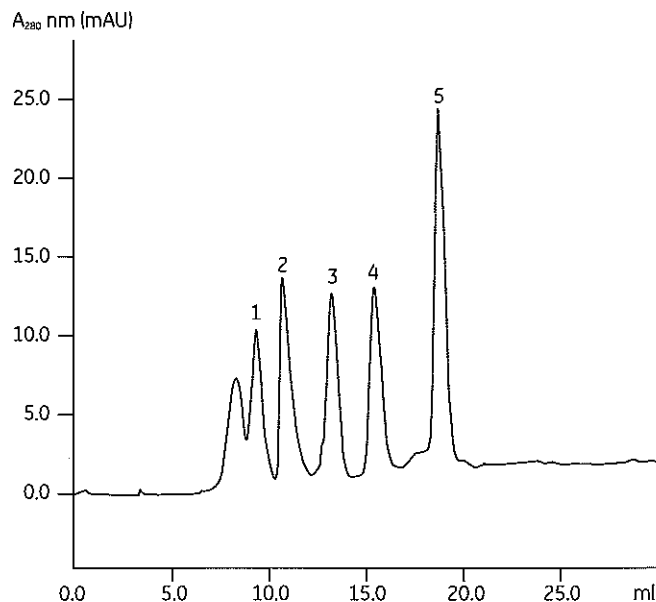

Fig 2. Typical chromatogram from a function test of Superdex 75 10/300 GL.

[www.gelifesciences.com/protein-purification](http://www.gelifesciences.com/protein-purification)

GE Healthcare Bio-Sciences AB  
Björkgatan 30  
751 84 Uppsala  
Sweden



GE Healthcare Europe GmbH  
Munzinger Strasse 5, D-79111 Freiburg, Germany  
GE Healthcare UK Ltd  
Amersham Place, Little Chalfont, Buckinghamshire, HP7 9NA, UK  
GE Healthcare Bio-Sciences Corp  
800 Centennial Avenue, P.O. Box 1327, Piscataway, NJ 08855-1327, USA  
GE Healthcare Japan Corporation  
Sonken Bldg, 3-25-1, Hyokunincho, Shinjuku-ku, Tokyo 169-0073, Japan

71-5017-96 AG 09/2010

## Column Superdex 200 10/300 GL

- Sample:
1. Thyroglobulin (M, 669 000) 5 mg/ml
  2. Ferritin (M, 440 000) 0.4 mg/ml
  3. BSA (M, 67 000) 8 mg/ml
  4.  $\beta$ -lactoglobulin (M, 35 000) 2.5 mg/ml
  5. Ribonuclease A (M, 13 700) 5 mg/ml
  6. Cytochrome C (M, 13 600) 1.5 mg/ml
  7. Aprotinin (M, 6 512) 2 mg/ml
  8. Vitamin B12 (M, 1 355) 0.1 mg/ml

Sample volume: 500  $\mu$ l  
 Eluent: 0.05 M phosphate buffer, 0.15 M NaCl, pH 7.0  
 Flow rate: 0.4 ml/min, room temperature  
 Detection: 280 nm

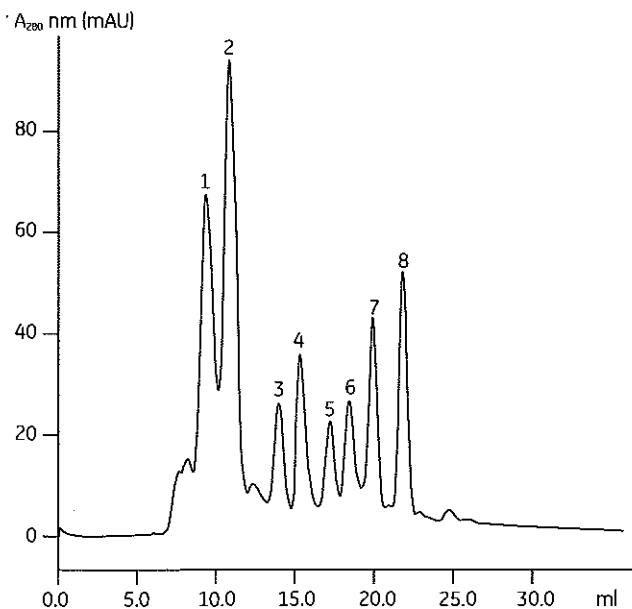

**Fig 3.** Typical chromatogram from a function test of Superdex 200 10/300 GL.  
 Note: Peak 5 and 6 are separated from each other only for difference in shape.

## Ordering information

Designation	No. per pack	Code No.
Superdex 75 10/300 GL	1	17-5174-01
Superdex 200 10/300 GL	1	17-5175-01

### Related products

Designation	No. per pack	Code No.
Superdex Peptide 10/300 GL	1	17-5176-01
Gel filtration LMW Calibration Kit	1	17-0442-01
Gel filtration HMW Calibration Kit	1	17-0441-01

### Accessories

Designation	No. per pack	Code No.
Filter Kit	1	18-1153-11
Filter tool	1	18-1153-20
Fingertight connector, 1/16" male	10	18-1112-55
Union M6 female/1/16" male	8	18-1112-58
On-line filter (1/16")	1	18-1118-01
1/16" male to luer female	2	18-1112-51
Storage/shipping device	1	18-1176-43
Handbook:		
Gel filtration Principles & Methods	1	18-1022-18

GE, Imagination at work and GE Monogram are trademarks of General Electric Company.

Superdex, Tricorn, ÄKTAdesign and FPLC are trademarks of GE Healthcare companies.

The Tricorn column and components are protected by US design patents USD500856, USD506261, USD500555, USD495060 and their equivalents in other countries.

All third party trademarks are the property of their respective owners.

© 2002-2010 General Electric Company – All rights reserved.

First published Mar. 2002

All goods and services are sold subject to the terms and conditions of sale of the company within GE Healthcare which supplies them. A copy of these terms and conditions is available on request. Contact your local GE Healthcare representative for the most current information.